

omporro 

officine meccaniche porro



ALFREDO
PORRO



MANUFACTURED BY OFFICINE MECCANICHE PORRO

COMPLEMENTI D'ARREDO IN METALLO NOBILE





officine meccaniche porro

ARTIGIANI DELL'ECCELLENZA

Nel 1946, dal laboratorio di Alfredo Porro, nasce Officine Meccaniche Porro e quello che era un laboratorio artigiano acquista le dimensioni di un'Azienda senza mai perdere la sua vocazione artigianale.

Negli anni '70 sarà il figlio Giuseppe ad allargare la gamma di prodotti di grande qualità concepiti e creati con passione, esteticamente pregevoli e tecnologicamente sempre all'avanguardia.

Tutti valori che sono passati anche alla terza generazione della famiglia: Fabio, Donata e Paola che continuano ad offrire una produzione in cui qualità, passione artigianale, estetica e la miglior tecnologia disponibile ben rappresentano l'Eccellenza Italiana in oltre 80 Paesi nel mondo.

EXCELLENCE IN CRAFTSMANSHIP

In 1946, Alfredo Porro transformed his workshop into Officine Meccaniche Porro, effectively turning a craft laboratory into a corporate endeavor that, however, never lost its artisanal roots.

In the 1970s, Alfredo's son, Giuseppe, broadened the range of high-quality, aesthetically valuable and technologically advanced products designed and created with passion.

These values have been passed on to the Porro Family's third generation: Fabio, Donata and Paola continue to offer today products whose quality, artisanal passion, aesthetics and state-of-the-art technology well represent Italian Excellence in more than 80 countries.

**ALFREDO
PORRO**



MANUFACTURED BY OFFICINE MECCANICHE PORRO

COMPLEMENTI D'ARREDO IN METALLO NOBILE

Il marchio, dedicato al nostro fondatore, contraddistingue la nostra produzione di complementi per mobili, tende e scale in cui la qualità delle materie prime, la funzionalità e l'aspetto decorativo raggiungono livelli estremamente elevati. Oggetti curati nel dettaglio, solidi e destinati a durare nel tempo e un gran numero di referenze, di stili, di materiali e di finiture che possono soddisfare ogni esigenza e completare, coerentemente, la nostra offerta di maniglie.

NOBLE METAL ACCESSORIES

Our brand, dedicated to our founder, defines our production of accessories for furniture, curtains and stairs whose raw material quality, functionality and decorative aspect reach extremely high levels. Solid, durable and carefully detailed items, as well as a large number of references, styles, materials and finishes that can meet any expectation and complete our range of handles.

ENRICO CASSINA

MANUFACTURED BY OFFICINE MECCANICHE PORRO

MANIGLIERIA DI PREGIO DAL 1850

Il prestigioso marchio Enrico Cassina rappresenta l'apice della qualità e dello stile nella maniglieria.

Veri «pezzi d'arte» artigianali nella purezza stilistica che va dal Barocco al Contemporaneo e che consente di completare coerentemente qualsiasi progetto architettonico o di interior design.

Prodotti unici e ricercati presenti nelle ville e negli hotel più prestigiosi in oltre 80 Paesi nel mondo e che, come tutta la produzione Officine Meccaniche Porro, sono garantiti 100% Made in Italy.

PRESTIGIOUS DOOR HANDLES SINCE 1850

The prestigious Enrico Cassina brand represents the pinnacle of quality and style in door handles. True artisanal "art pieces" whose style ranges from the Baroque to Contemporary themes, and allows completing any architectural or interior design project. Unique and sophisticated products installed in the most prestigious villas and hotels in more than 80 countries, and which, like all Officine Meccaniche Porro production, are guaranteed, 100% Made-in-Italy creations.



IL PERFETTO
INCONTRO
TRA INDUSTRIA
E DESIGN

THE PERFECT
MATCH BETWEEN
MANUFACTURING
AND DESIGN



ALFREDO PORRO



MANUFACTURED BY OFFICINE MECCANICHE PORRO

In occasione del settantesimo anno di vita delle Officine Meccaniche Porro, Fabio, Donata e Paola Porro hanno voluto dedicare al nonno Alfredo la gamma di complementi d'arredo per mobili, tende e scale.

È nel 1946, infatti, che Alfredo Porro compie il grande passo, da bottega artigiana per la riproduzione di chiavi fonda le Officine Meccaniche Porro.

L'Officina di Cantù - rinominata Officine Meccaniche Porro - diventa presto punto di riferimento per i più importanti mobilifici e falegnamerie della zona, la Brianza, ovvero quella zona a nord di Milano che è famosa proprio per la produzione di mobili e infissi.

La qualità delle materie prime utilizzate e delle lavorazioni, spesso rifinite a mano una ad una, non si discutono. Alfredo Porro poteva rompere un'amicizia decennale per il suggerimento di utilizzare la zama, lega povera e meno costosa dell'ottone ma con la stessa resa estetica, la sua filosofia era «qualità» prima di tutto.

Il figlio Giuseppe affiancherà il padre per poi prendere le redini dell'Azienda e, oggi, è la terza generazione della Famiglia Porro che continua una produzione contraddistinta da qualità delle materie prime, cura artigianale nelle lavorazioni, ricerca di sempre migliori tecnologie.

In Officine Meccaniche Porro, oggi come nel 1946, anche il più piccolo pomolino deve essere fatto al meglio e con i migliori prodotti utilizzabili.

Tutti prodotti del marchio Alfredo Porro sono 100% Made in Italy, garanzia di alta qualità, attenzione al dettaglio e design impeccabile. In sintesi: tutti i prodotti Alfredo Porro possono fregiarsi, senza tema di smentita, del titolo di prodotti dell'Eccellenza Italiana nel mondo.

On the occasion of Officine Meccaniche Porro's 70th birthday, Fabio, Donata and Paola Porro dedicated to grandpa Alfredo a complete catalog of accessories for furniture, curtains and stairs.

It was 1946, indeed, when Alfredo Porro made the big leap, transforming his artisan workshop into Officine Meccaniche Porro.

The Cantù facilities, renamed Officine Meccaniche Porro, became a reference point for the most important furniture makers and carpenters of the Brianza region, an area north of Milan famous for the production of furniture, as well as windows and doors.

The quality of the raw materials used and the handiwork were, and still are, unquestionable. For his creations and in honor of his "quality-above-all" philosophy, Alfredo Porro chose to use brass over zinc alloy, which, though cheaper than and similar in appearance to brass, was qualitatively weaker.

Giuseppe Porro joined his father, eventually taking the company's helm, which is today held by the family's third generation. Production continues, always distinguished by the high quality of raw materials, accurate handiwork and search of the best technology.

Today, as in 1946, at Officine Meccaniche Porro even the smallest knob must be perfect, so it is made using the best materials available.

All Alfredo Porro brand products are 100% Made in Italy. They guarantee top quality, care in every detail and impeccable design.

In short: all Alfredo Porro products can unquestionably claim to embody Italian Excellence in the world.



MANIGLIE PER MOBILE CABINET HANDLES	pag page	5
POMOLI PER MOBILE CABINET KNOBS	pag page	15
BOCCHETTE PER MOBILE CABINET ESCUTCHEONS	pag page	21
CHIAVI PER MOBILE CABINET KEYS	pag page	23
FREGI E CIMASE CABINET DECORATIONS	pag page	26
CERNIERE E CATENELLE MOBILE CABINET HINGES AND CABINET CHAINS	pag page	34
PUNTALI E PIEDINI PER MOBILE CABINET FEET	pag page	37
GANCI HOOKS	pag page	39
ACCESSORI TENDE E SCALE CURTAINS AND STAIRS ACCESSORIES	pag page	41
RELING RELING	pag page	56
MANIGLIE INCASSO FLUSH HANDLES	pag page	61
MANIGLIE VETRO HANDLES FOR GLASS DOORS	pag page	67
APPENDIABITI E PORTACHIAVI COAT HANGERS AND HOTEL KEY-RINGS	pag page	70
REGGIPENSILI E REGGIMENSOLE WALL BRACKETS AND SHELF BRACKETS	pag page	73
ACCIAIO INOX STAINLESS STEEL	pag page	76
ACCESSORI ACCESSORIES	pag page	80



**MANIGLIE PER MOBILE
CABINET HANDLES**



491
128 (164xØ14)
160 (196xØ14)
320 (356xØ14)



491MA_T
 65xØ14



C02990
128 (164x15)
192 (228x15)
320 (356x15)



C10190
128 (143x16)
192 (207x16)
320 (335x16)



C09590
96 (108x14)
120 (140x14)



C17890
96 (134x18)
128 (166x18)



461
96 (147x12)
160 (208x14)



406
96 (125x20)
160 (200x22)



C03090
128 (160x30)
160 (192x30)





529
64 (130x64)



530
64 (120x32)



538 V
160 (14x174)
192 (14x206)
256 (14x270)



464
96 (136x39)
128 (168x39)
160 (200x39)
192 (232x39)
320 (360x39)
480 (520x39)



MODERN



400
32 (42x9)
64 (78x11)
96 (110x11)



451
64 (100x26)
96 (144x34)



454
64 (92x39)



472
64 (83x36)
96 (96x115)



522
64 (81x11)
96 (121x15)
192 (215x15)



489
75 (81x43)
100 (97x54)



499
34 (34x37)
40 (40x43)
50 (50x53)

CLASSIC





440
64 (68x26)
72 (85x32)
100 (113x42)
115 (128x47)



441
96 (110x36)



465
80 (81x46)
100 (101x60)



466
60 (58x48)



422
(35x64)



443
72 (96x39)
100 (133x52)



424
50 (28x68)
70 (34x92)



467
50 (22x61)



425
95 (24x107)
120 (30x136)



420
75 (103x41)
95 (129x52)



423
90 (91x29)
130 (129x34)
190 (194x51)
240 (244x51)



433
50 (50x53)





645
32 (31x48)
43 (43x66)



432
96 (127x46)



456
140 (141x41)



435
100 (100x37)
125 (120x42)
160 (160x52)
210 (201x68)



470
90 (88x22)
120 (119x35)



413
65 (82x30)
80 (102x38)
90 (112x41)



412
65 (83x33)
80 (102x40)
90 (114x45)

POMOLI PER MOBILE CABINET KNOBS





491PO
(35x27)



C02990 PO
(15x30)



C17890_PO
30 (33x19)
42 (42x24)



C03090_PO
Ø30 (h 24)
Ø40 (h 32)



165
15 (15x20)
20 (20x27)
25 (25x33)
30 (30x39)
35 (35x45)



523
23 (18x30)



105
25 (25x15)
30 (30x20)
35 (34x23)



170
25 (25x25)
30 (30x30)
35 (35x35)



461 P
48 (21x48)



151
25 (25x23)
30 (30x27)



158
20 (20x20)
25 (25x25)
30 (30x30)
35 (35x33)
40 (40x33)



153
12 (12x19)
15 (15x22)
18 (18x24)
21 (21x27)
25 (25x32)



AI0153
15 (15x22)
18 (18x24)
21 (21x27)



AI0181
20 (20x24)
24 (24x29)



AI0180
20 (20x22)
25 (25x27)
30 (30x32)





160
21 (20x19)
26 (25x21)
32 (32x23)
40 (40x26)



100
20 (20x18)
25 (25x22)
31 (31x28)



101
20 (20x16)
25 (25x20)
30 (30x23)



142
25 (25x19)
30 (30x22)
35 (35x25)



163
30 (21x30)
35 (24x35)
40 (28x40)



161
17 (17x17)
21 (20x20)
26 (25x23)
32 (32x26)
40 (40x29)



145
30 (30x25)
40 (39x31)



146
25 (25x19)
30 (30x22)
40 (39x27)



141
30 (30x26)
35 (35x31)
40 (40x35)

CLASSIC





102
25 (25x24)
30 (30x28)
40 (40x37)



164
25 (25x18)
30 (30x22)
35 (35x25)
40 (40x28)



168
25 (26x26)
30 (30x30)
35 (35x35)



140
25 (25x17)
30 (30x18)
35 (34x19)



130
15 (15x16)
20 (20x18)
25 (25x22)
30 (30x26)
35 (35x30)



135
30 (30x23)
35 (35x27)



120
25 (25x21)
30 (31x23)
35 (35x29)

BOCCHETTE PER MOBILE CABINET ESCUTCHEONS





C17890_BO
(24x42)



336
Ø25
Ø30
Ø35



332
(18x35)



300
29 (20x29)
37 (26x37)
47 (32x47)



421
Ø33



437
85 (85x45)



455
55 (36x55)



310V dx/sx
90 (16x90)
170 (25x166)

CHIAVI PER MOBILE CABINET KEYS





15
30 (26x66)
40 (26x76)
45 (26x81)



74
30 (30x62)
40 (30x72)



28
30 (35x61)
40 (35x71)



33
30 (27x56)
35 (27x61)
40 (27x66)
45 (27x71)



55
35 (26x68)
45 (26x78)



48
32 (20x64)
42 (20x74)



45
35 (28x68)
42 (28x75)



30
33 (35x62)
42 (35x73)



30 T
 (35x32)



26
30 (28x60)
35 (28x65)
40 (28x70)
45 (28x75)



26 T
 (28x30)



44
33 (23x67)
45 (23x79)



41
35 (29x70)
45 (29x80)



17
30 (31x72)
38 (31x80)



29
33 (32x79)
42 (32x88)



16
30 (33x74)
40 (33x84)

A photograph of a highly ornate, white-painted cabinet with intricate gold leaf carvings. The cabinet features a large, oval-shaped medallion on its front panel, surrounded by elaborate scrollwork and floral motifs. The sides of the cabinet are decorated with a diamond-patterned lattice. The cabinet stands on four decorative, fluted legs. To the left, a matching ornate chair with a high back and gold leaf accents is visible. The setting is a room with dark wood paneling on the walls and a large window with white curtains. The floor is made of polished wood with a parquetry pattern. The lighting is warm, highlighting the textures and colors of the furniture.

FREGI E CIMASE
CABINET DECORATIONS



207
48 (48x33)
70 (70x50)



208
30 (42x42)
40 (56x56)



348
(232x67)



347
(260x77)



344
(167+48+167)x35



209
Ø36



210
Ø35



211
Ø48



212
Ø43



1071
160 (33x166)
210 (37x216)



200
Ø19
Ø24
Ø28
Ø33
Ø42



343
(22x166)



342
(71x147)



331
(60x71)



333
(48x58)



334
(88x92)





303
(158x29)



302
(240x47)



335
(30x158)



329
(87x131)



213
Ø46



345
(69+46+69)x46



346
(104+46+104)x46

CIMASE CABINET DECORATIONS



1070
130 (31x131)
140 (40x140)
230 (54x226)



1063 CM
 (48x182)



1064 CM
 (43x154)



1062 CM
 (37x206)

FREGI PER PIEDINO MOBILE DECORATIONS FOR CABINET FEET



1063 PI
 (28x87)



1060
 (35x98)



1061
 (31x81)



1064 PI
 (36x91)



1062 PI
 (46x117)



CLASSIC

**CERNIERE E
CATENELLE MOBILE
CABINET HINGES
AND CABINET CHAINS**

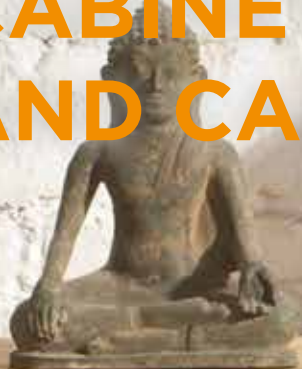



473 BIS
(48x66)



473
(57x65)



473 BA
(57x65)



474
63 (35x63)
75 (35x76)



760 CG

- 150
- 200
- 250
- 300
- 350
- 400
- 500



760 FS

- 150
- 200
- 250
- 300
- 350
- 400
- 500



761

- 150
- 200
- 250
- 300
- 350
- 400
- 500



**PUNTALI E PIEDINI
PER MOBILE
CABINET FEET**

PUNтали E PIEDINI PER MOBILE CABINET FEET

PUNтали CABINET FEET



1015
25 (33x32)
30 (39x37)
35 (44x40)



1010
21 (28x24)
23 (31x26)
25 (34x28)
30 (41x32)
35 (46x35)

PIEDINI CABINET FEET



1026
100 (40x100)
150 (40x150)



1025
100 (32x100)
150 (32x150) *



1029
100 (32x100)
150 (32x150)



1040
120 (32x120)
150 (32x150) #



AP01*
65 (126x95)



AP02*
60 (60x60)



AP04 #
72 (72x25)

* # : Prodotti abbinabili anche con: * #
 * # : Products also combinable with: * #

GANCI
HOOKS





1505
20 (22x18)
28 (29x22)
35 (35x27)
42 (42x32)
50 (51x38)



1509
25 (10x25)
35 (13x35)
45 (17x45)



1506
20 (25x34)
28 (32x24)
35 (38x27)
42 (45x33)
50 (54x33)



1510
30 (15x30)
50 (23x45)
75 (35x75)
100 (46x100)



1520
30 (18x30)
50 (30x53)
75 (45x86)
100 (60x115)

**ACCESSORI
TENDE E SCALE
CURTAINS AND STAIRS
ACCESSORIES**



SUPPORTI TENDA CURTAINS BRACKETS

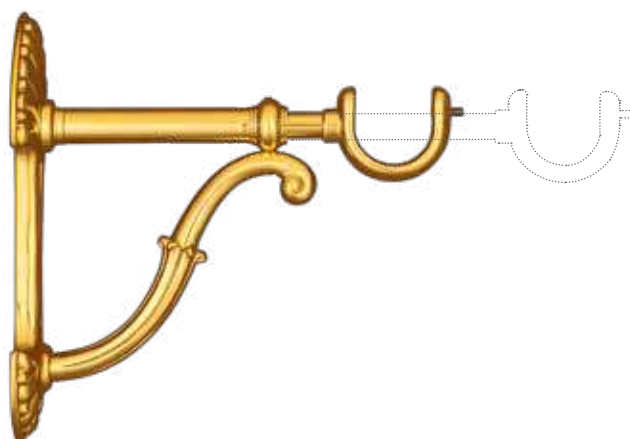

800
Ø25 (160/240x173) **Ø25** (220/290x173)
Ø30 (163/240x173) **Ø30** (223/293x173)
Ø35 (165/240x173) **Ø35** (225/295x173)

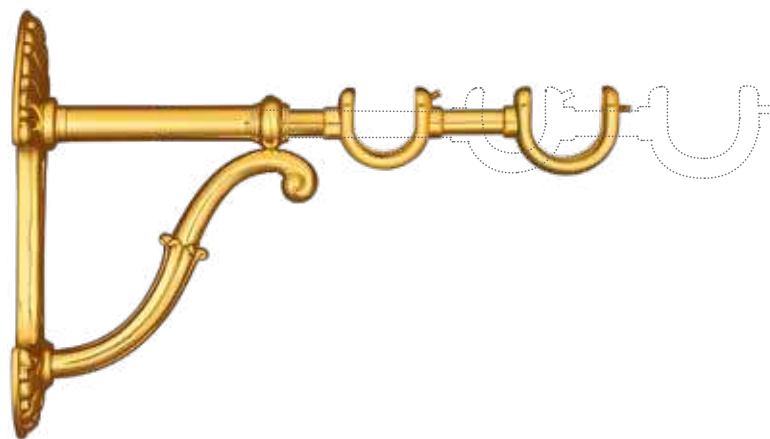

800 D
Ø25/Ø30 (242/322x173)

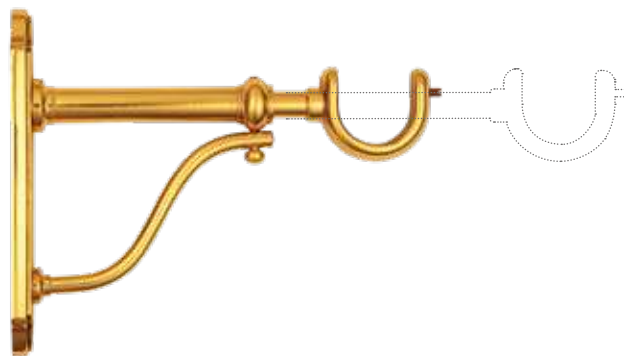

867
Ø30 (163/240x140)
Ø30 (223/293x140)
Ø35 (165/240x140)
Ø35 (225/295x140)

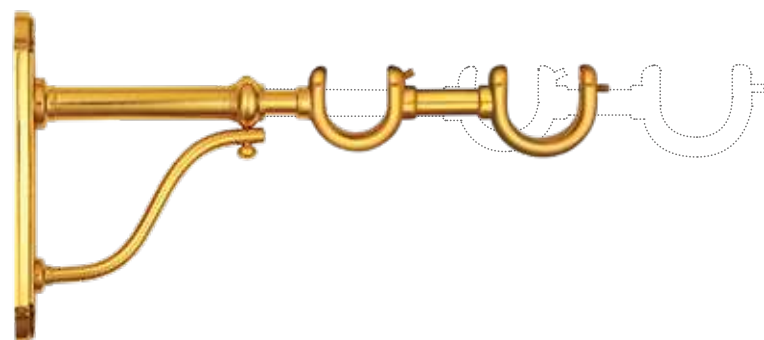

867 D
Ø25/Ø30 (242/322x142)



801
Ø25x120 (151x84) **Ø30x120** (157x84)
Ø25x180 (211x84) **Ø30x180** (217x84)
Ø25x240 (267x84) **Ø30x240** (273x84)
Ø35x120 (163x84)
Ø35x180 (223x84)
Ø35x240 (279x84)



801 D
Ø25/Ø30 (348x84)



EVERGREEN

SUPPORTI TENDA CURTAINS BRACKETS



880
Ø25/Ø30 (233x74)



845
Ø20x70 (94x60) **Ø35x70** (109x60)
Ø20x120 (144x60) **Ø35x120** (159x60)
Ø20x180 (204x60) **Ø35x180** (219x60)

Ø25x70 (99x60)
Ø25x120 (149x60)
Ø25x180 (209x60)

Ø30x70 (104x60)
Ø30x120 (154x60)
Ø30x180 (214x60)



888
Ø25 (152x69)
Ø30 (157x69)
Ø35 (163x69)



845 A
Ø25x70 (104x60) **Ø30x70** (110x60)
Ø25x120 (154x60) **Ø30x120** (160x60)
Ø25x180 (214x60) **Ø30x180** (220x60)

Ø35x70 (115x60)
Ø35x120 (165x60)
Ø35x180 (225x60)



874 dx/sx
 Ø16 (48x59)
 Ø20 (48x61)
 Ø25 (48x62)
 Ø30 (48x65)



874 A
 Ø16 (48x59)
 Ø20 (48x61)
 Ø25 (48x62)
 Ø30 (48x65)



861 A
 Ø11 (18x30)
 Ø13 (18x30)
 Ø25x30 (34x58)
 Ø25x50 (34x58)
 Ø30x30 (34x60)
 Ø30x50 (34x60)



861 dx/sx
 Ø11 (18x30)
 Ø13 (18x30)
 Ø25x50 (34x88)
 Ø30x50 (34x90)



844
 Ø11x20 (20x30) Ø13x20 (20x30)
 Ø11x40 (20x50) Ø13x40 (20x50)
 Ø11x70 (20x80) Ø13x70 (20x80)



865
 Ø16 (44x54)
 Ø20 (48x64)
 Ø25 (53x81)



1509
25 (25x25)
35 (35x35)
45 (45x45)



803
Ø13 (19x45)
Ø18 (26x62)
Ø20 (28x68)
Ø25 (35x85)



1506
20 (25x24)
28 (32x24)
35 (38x27)
42 (45x33)
50 (54x33)



1505
20 (22x18)
28 (29x22)
35 (35x27)
42 (42x32)
50 (51x38)



879
1500 (16x1560)



901
Ø13 (25x32)
Ø20 (33x43)
Ø25 (41x51)
Ø30 (46x67)
Ø35 (52x63)
Ø40 (60x71)



901 N
Ø25 (41x51)
Ø30 (46x67)
Ø35 (52x63)
Ø40 (60x71)

L'anello in nylon rende più silenzioso lo scorrimento della tenda e preserva la finitura del tubo.

The nylon ring makes the sliding of the curtain quieter and protects the finish of the curtain rail.



872
120 (127x70)
180 (187x70)



899
120 (144x69)
180 (204x69)



510
85 (45x85)

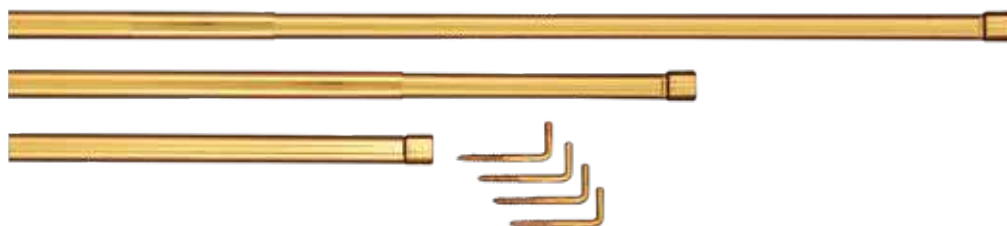

870

- 30** (300/500)
- 40** (400/600)
- 50** (500/800)
- 60** (600/1000)



852 GI

- 25** (60x25)
- 30** (60x30)
- 35** (60x35)
- 40** (60x40)

RACCORDO A SCOMPARSA
HIDDEN JOINT

TUBES



TUBES



TUBI TUBES

852

Ø9 (9x1500)	Ø11 (11x1500)	Ø13 (13x1500)
Ø9 (9x2000)	Ø11 (11x2000)	Ø13 (13x2000)
Ø9 (9x3000)	Ø11 (11x3000)	Ø13 (13x3000)

Ø16 (16x1500)	Ø20 (20x1500)	Ø25 (25x1500)
Ø16 (16x2000)	Ø20 (20x2000)	Ø25 (25x2000)
Ø16 (16x3000)	Ø20 (20x3000)	Ø25 (25x3000)

Ø30 (30x1500)	Ø35 (35x1500)	Ø40 (40x1500)
Ø30 (30x2000)	Ø35 (35x2000)	Ø40 (40x2000)
Ø30 (30x3000)	Ø35 (35x3000)	Ø40 (40x3000)



852 R

Ø25 (25x2000)	Ø30 (30x2000)	Ø35 (35x2000)
Ø25 (25x3000)	Ø30 (30x3000)	Ø35 (35x3000)

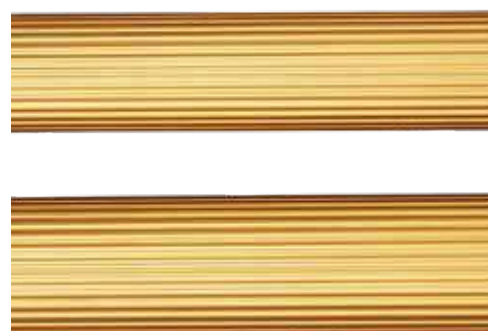

FINALI END-KNOBS



802
25 (44x63)
30 (53x75)
35 (62x86)



854
20 (32x43)
25 (42x49)
30 (49x58)
35 (54x60)
40 (59x65)



857
20 (32x49)
25 (42x59)
30 (49x70)
35 (54x72)
40 (59x75)



900
20 (24x8)
25 (29x11)
30 (34x13)
35 (40x14)
40 (44x15)



883
Ø11 (20x21)
Ø13 (22x23)



903
Ø11 (14x14)
Ø13 (16x15)



850
Ø9 (9x9)
Ø11 (11x12)
Ø13 (13x13)
Ø16 (16x15)



853
Ø20 (24x62)
Ø25 (29x90)
Ø30 (34x90)



860
Ø10 (16x23)
Ø12 (18x25)
Ø14 (20x27)
Ø17 (22x31)



849
620 (620x30)
820 (820x30)
1020 (1020x30)



851

- Ø9 (9x700)
- Ø9 (9x800)
- Ø9 (9x900)
- Ø9 (9x1000)

- Ø11 (11x700)
- Ø11 (11x800)
- Ø11 (11x900)
- Ø11 (11x1000)

- Ø13 (13x700)
- Ø13 (13x800)
- Ø13 (13x900)
- Ø13 (13x1000)
- Ø13 (13x1100)

- Ø16 (16x900)
- Ø16 (16x1000)
- Ø16 (16x1100)
- Ø16 (16x1200)



868

- Ø12 (44x37)
- Ø14 (44x37)
- Ø16 (44x37)



EVERGREEN

ACCESSORI TENDE E SCALE CURTAINS AND STAIRS ACCESSORIES

SUPPORTI PER TENDE E SCALE CURTAINS AND STAIRS BRACKETS



855
 Ø20 (50x71)
 Ø25 (60x86)
 Ø30 (69x94)
 Ø35 (69x110)



856
 Ø25 (60x86)
 Ø30 (69x94)
 Ø35 (69x109)



858
 Ø30 (69x119)
 Ø35 (69x124)
 Ø40 (69x129)



SUPPORTI CORRIMANO HANDRAIL BRACKETS



863
 Ø30 (69x116)
 Ø35 (69x122)
 Ø40 (69x127)



863 E
 Ø30 (55x103)
 Ø35 (55x108)
 Ø40 (55x113)



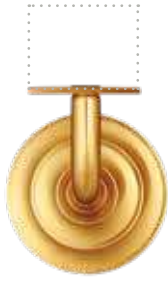

859
75 (69x77)



859 E
65 (55x116)



869
Ø20 (64x34)
Ø25 (69x35)
Ø30 (76x32)
Ø35 (76x35)
Ø40 (76x35)



869 C
Ø20 (64x53)
Ø25 (69x53)
Ø30 (76x53)
Ø35 (76x53)
Ø40 (76x53)



RELING
RELING





840

Ø11 (20x13)

Ø13 (23x15)

Ø16 (25x16)



841 dx/sx

Ø20 (31x17)

Ø25 (42x18)



842

Ø11 (15x20)

Ø13 (17x20)

Ø16 (20x20)

Ø20 (24x20)

Ø25 (29x20)

Ø30 (35x20)



883

Ø11 (20x21)

Ø13 (22x23)



903

Ø11 (14x14)

Ø13 (16x15)



850

Ø9 (9x9)

Ø11 (11x12)

Ø13 (13x13)

Ø16 (16x14)



852

Ø9 (9x1500)

Ø9 (9x2000)

Ø9 (9x3000)

Ø13 (13x1500)

Ø13 (13x2000)

Ø13 (13x3000)

Ø11 (11x1500)

Ø11 (11x2000)

Ø11 (11x3000)

Ø16 (16x1500)

Ø16 (16x2000)

Ø16 (16x3000)

Ø20 (20x1500)

Ø20 (20x2000)

Ø20 (20x3000)

Ø25 (25x1500)

Ø25 (25x2000)

Ø25 (25x3000)

Ø30 (30x1500)

Ø30 (30x2000)

Ø30 (30x3000)



865

Ø16 (44x54)

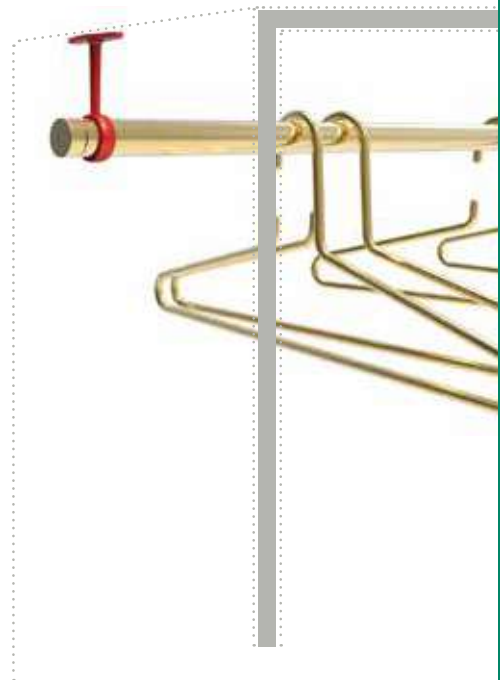
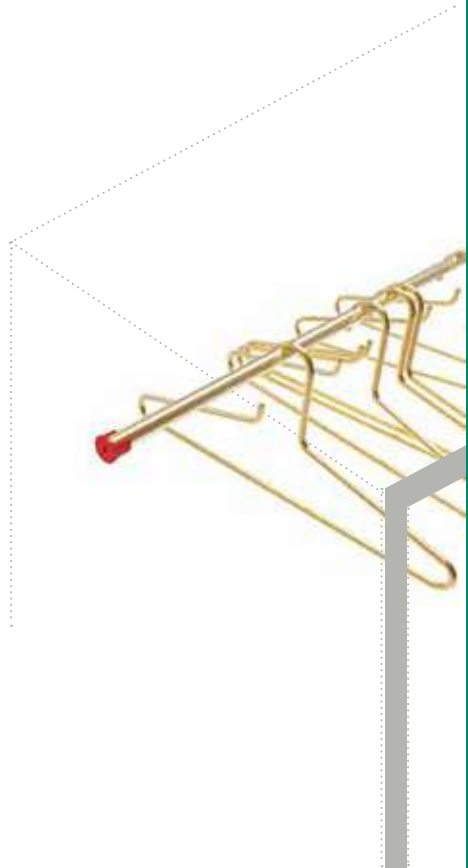

RELING RELING

SISTEMA RELING RELING SYSTEM



2010
Ø16 (18x11)



2000
Ø16 (22x46)



2001
Ø11x40 (14x40)
Ø13x40 (18x41)
Ø16x40 (20x45)

Ø11x70 (14x70)
Ø13x70 (18x70)
Ø16x70 (20x70)



803
Ø13 (19x45)
Ø18 (26x62)
Ø20 (28x68)
Ø25 (35x85)



3075
Ø16 (16x1000)
Ø16 (16x1500)
Ø16 (16x2000)
Ø16 (16x2500)
Ø16 (16x3000)



EVERGREEN

RELING RELING

POGGIAPIEDI BRACKETS FOR FOOTREST



1000
35 (211x211)

1001
35 (211x160)



MANIGLIE INCASSO FLUSH HANDLES



MANIGLIE INCASSO FLUSH HANDLES

MAGNETICHE MAGNETICS

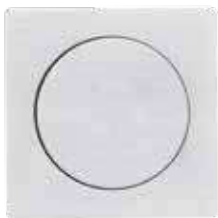
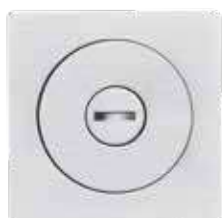
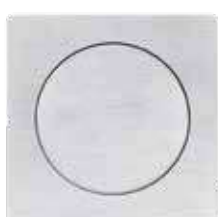
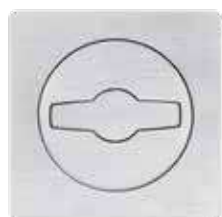

590 AC Kit Pull
60 (57x57)

590 Kit Pull
60 (57x57)

592 Kit Pull
50 (52x52)

592
50 (52x52)



594
Ø30



593
140 (45x140)
160 (45x160)
200 (45x200)



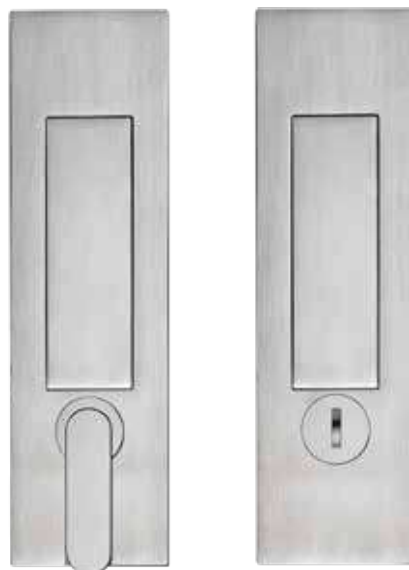
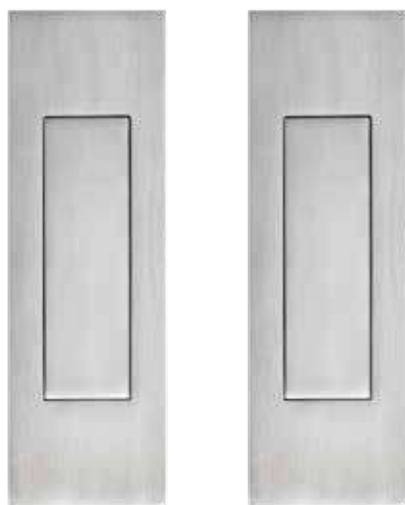

593 Kit Pull
140 (45x140)
160 (45x160)
200 (45x200)

593 AC Kit Pull
160 (45x160)



MANIGLIE INCASSO FLUSH HANDLES

MAGNETICHE MAGNETICS

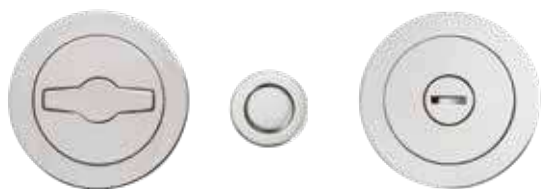

589 AC Kit Pull
Ø57



589 Kit Pull
Ø57



594 A
Ø60

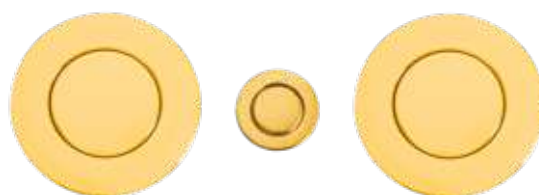

594 A Kit Pull
Ø60

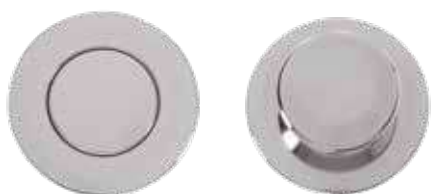

594 C
Ø60

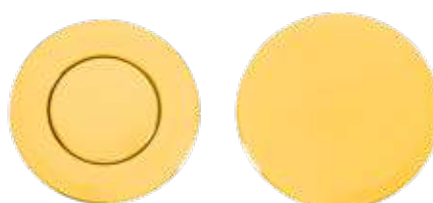

594 B
Ø60



598 OV FC
128 (37x141)
160 (37x173)



598 OV
64 (37x76)
96 (37x109)
128 (37x141)
160 (37x173)



595
 Ø30 Ø60
 Ø40 Ø80
 Ø50 Ø120
 Ø55



593 A FC
140 (45x140)
160 (45x160)
200 (45x200)



593 A
140 (45x140)
160 (45x160)
200 (45x200)



598 FC
128 (42x142)
160 (42x174)



598
64 (42x78)
96 (42x110)
128 (42x142)
160 (42x174)



MANIGLIE INCASSO PER MOBILE CABINET FLUSH HANDLES



596
30 (29x29)
40 (39x39)
50 (52x52)
60 (60x60)



588
60 (47x66)



580
 Ø50



587
40 (30x40)
50 (38x51)
60 (47x60)



587 BA
40 (30x40)
50 (38x51)
60 (47x60)



595
 Ø30
 Ø40
 Ø50



598
64 (42x78)
96 (42x110)
128 (42x142)
160 (42x174)



**MANIGLIE VETRO
HANDLES FOR
GLASS DOORS**



597 A
Ø60



597 B
Ø60



597 C
Ø60

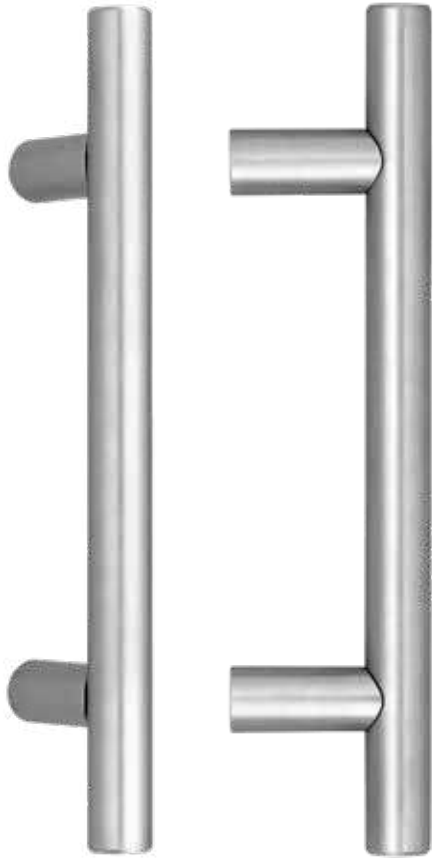

A10464 V
160 (Ø16x200)
192 (Ø16x232)
256 (Ø16x296)



538 V
160 (14x174)
192 (14x206)
256 (14x270)

**APPENDIABITI
E PORTACHIAVI
COAT HANGERS
AND HOTEL
KEY-RINGS**





1517
35 (35x41)xh55



AI1542
14 (Ø35xh46)



1516
82 (65x43)



1522
31 (31x41)



1504
(200x41)



2070
265 (265x95)



C58000
(44x70)



C58200
(34x74)



C58100
(46x87)



1540
(102x170)



1535
(73x148)

PORTACHIAVI HOTEL KEY-RINGS



511
110 (36x80)



510
85 (45x85)



**REGGIPENSILI
E REGGIMENSOLE
WALL BRACKETS
AND SHELF BRACKETS**

REGGIPENSILI WALL BRACKETS



2025
1000 (Ø20-35x1000)
1200 (Ø20-35x1200)

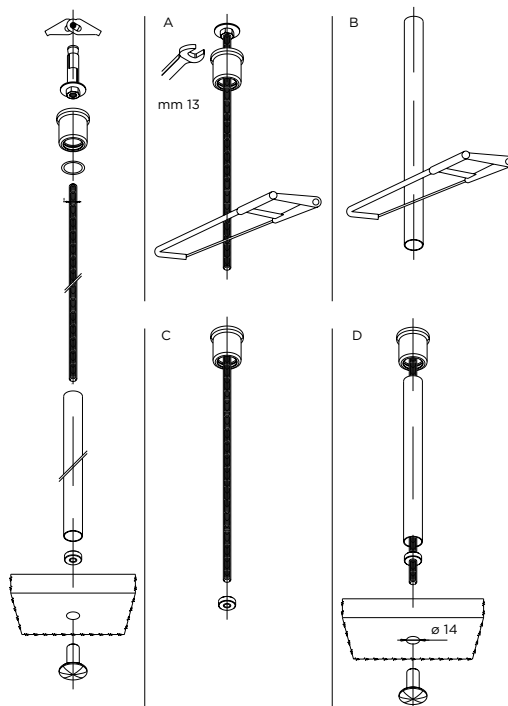

AI2025
1000 (Ø20-35x1000)
1200 (Ø20-35x1200)





2001 M

6 (26x20)

8 (26x20)

10 (28x24)



2000 M

8 (26x20)

10 (28x24)



PF2000

170 (170x99)



ACCIAIO INOX STAINLESS STEEL





AI0466

- | | |
|---------------------|---------------------|
| 96 (116x10) | 320 (340x10) |
| 128 (148x10) | 480 (500x10) |
| 160 (180x10) | 640 (660x10) |
| 192 (212x10) | 736 (756x10) |
| 224 (244x10) | |



AI0464 S

- | | |
|----------------------|----------------------|
| 96 (Ø12x176) | 352 (Ø12x432) |
| 128 (Ø12x208) | 416 (Ø12x496) |
| 160 (Ø12x240) | 448 (Ø12x528) |
| 192 (Ø12x272) | 480 (Ø12x560) |
| 224 (Ø12x304) | 640 (Ø12x720) |
| 320 (Ø12x400) | 736 (Ø12x816) |



AI0181

- 20** (20x24)
24 (24x29)



AI0180

- 20** (20x22)
25 (25x27)
30 (30x32)



AI0153

- 15** (15x22)
18 (18x24)
21 (21x27)

POMOLI ACCIAIO INOX STAINLESS STEEL KNOBS

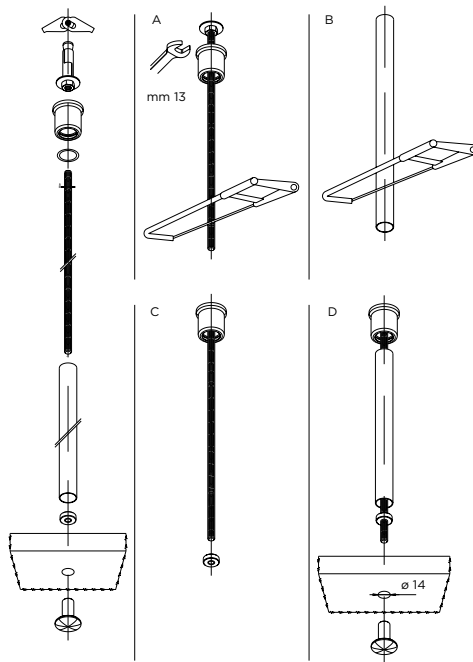

AI2025
1000 (Ø20-35x1000)
1200 (Ø20-35x1200)

APPENDIABITO COAT HANGER



AI1542
14 (Ø35xh46)

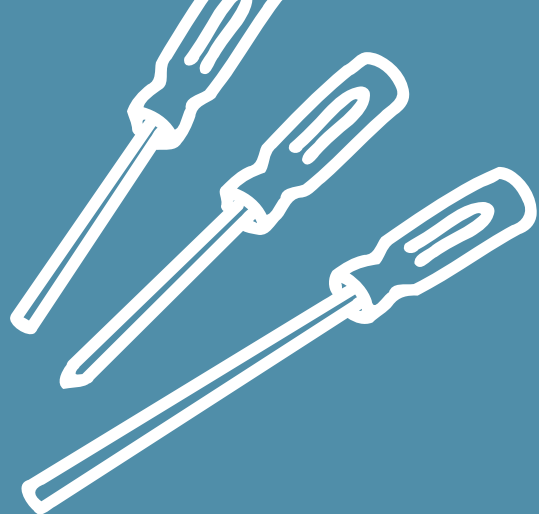
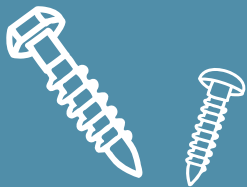

ACCESSORI ACCESSORIES

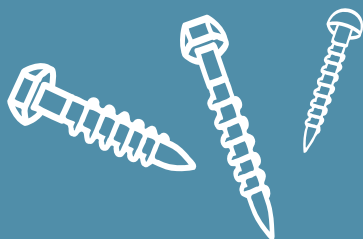
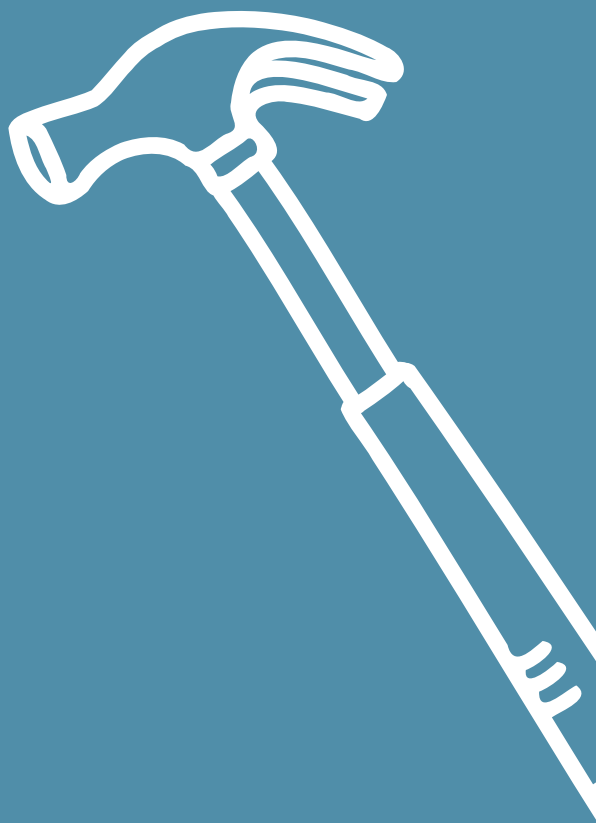
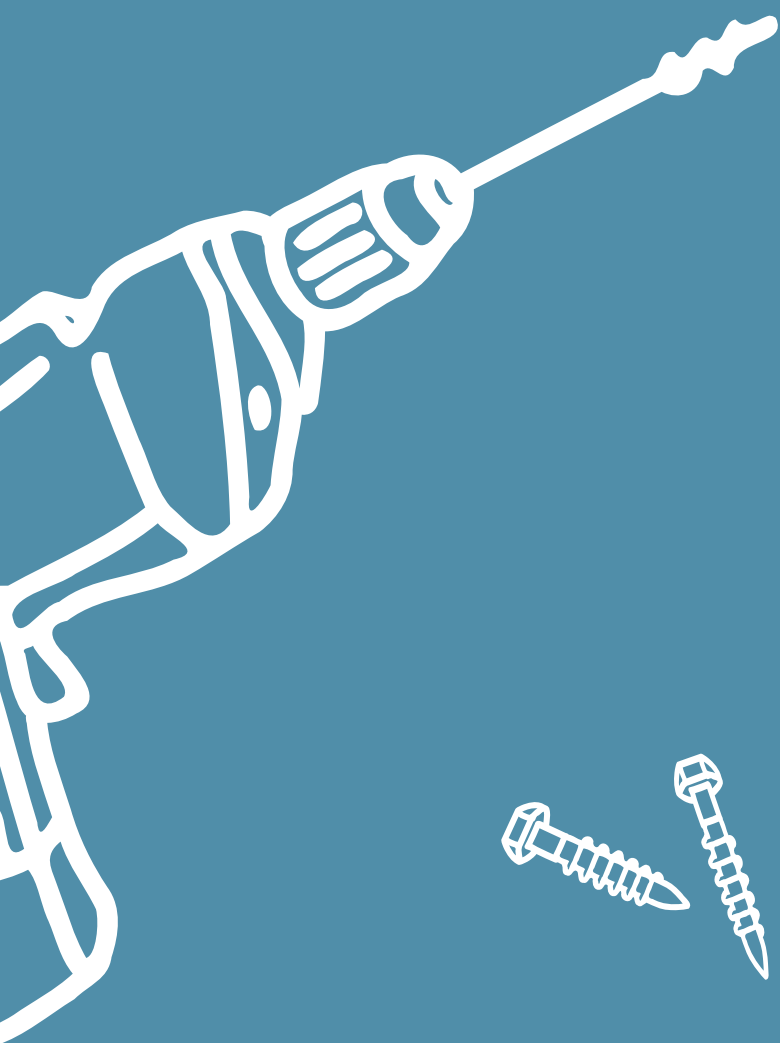



***CV001**
(31x13)



SV
075 (25xM4)
080 (50xM4)
081 (55xM4)



852 GI
25 (60x25)
30 (60x30)
35 (60x35)
40 (60x40)



AP04
72 (72x25)



AP01
65 (126x95)



AP02
60 (60x60)



SV114
17



SV128
(45xM4)



SOLO METALLI NOBILI
E LAVORAZIONI
ACCURATE

ONLY NOBLE METALS
AND DETAILED
MANUFACTURING

**STAMPAGGIO
A CALDO**



**HOT
FORGING**

La tecnologia dello stampaggio a caldo ha preso il posto della tradizionale fusione in quanto consente di ottenere prodotti con forme complesse e una qualità costante.

Hot forging replaced the traditional metal casting process, since it allows producing more consistent and higher quality products.

**PVD
(PHYSICAL VAPOUR
DEPOSITION)**



**PVD
(PHYSICAL VAPOUR
DEPOSITION)**

Processo di deposizione molecolare in condizioni di alto vuoto e ad alte temperature, conferisce ai nostri prodotti un'elevatissima resistenza agli agenti chimici e atmosferici e illimitata resistenza all'ossidazione. La resistenza antigraffio è di 4 volte superiore ai normali rivestimenti galvanici.

Physical Vapour Deposition, or molecular deposition process in high vacuum conditions and at high temperatures, gives our products an extreme resistance to chemical agents and meteorological elements, as well as unlimited resistance to oxidation. Anti-scratch resistance is 4 times higher than what is yielded by standard galvanized coating.

CESELLATURA



CHISELLING

Nonostante l'uso di stampi, siano essi gli storici o i più moderni delle collezioni contemporanee, alcuni particolari decorativi richiedono ancora la mano esperta del Mastro Cesellatore che va a rifinire e portare al dovuto risalto i particolari più minuti ottenendo un vero e proprio «pezzo d'arte» unico e immediatamente distinguibile.

Despite the use of molds, whether from historical or more contemporary collections, some decorative details still require the expert hand of the Master Chiseller, who refines and enhances the smallest details, thus producing a true, unique and immediately recognizable "art piece".

DIAMANTATURA



DIAMOND DRESSING

Facciamo «brillare» i nostri prodotti come un gioiello prezioso con questa lavorazione che consente di ottenere purezza geometrica, planarità delle superfici e un'estrema luminosità utilizzando, allo scopo, un diamante grezzo.

We give our products the "brightness" of precious jewels. Polishing objects with a rough diamond gives our products geometric purity, flat surfaces and extreme brightness.

LAVORAZIONE ARTIGIANALE



CRAFTSMANSHIP

Ai nostri complementi applichiamo tecniche di produzione e di finitura altamente tecnologiche ma ci sono oggetti che richiedono, ancora, tutta la maestria artigiana - maturata in 70 anni di storia - per ricevere finiture specifiche e manuali quali, ad esempio, le sfumature delle finiture in oro antico.

To our products, we apply state-of-the-art manufacture and finishing techniques. However, some items still require the employment of the craftsmanship we honed in 70 years of activity, such as, for instance, antique gold finish shading.

MAGNETE



MAGNET

Un brevetto con magneti al neodimio, esclusivo e registrato da Officine Meccaniche Porro, e le nostre maniglie - da incasso a levitazione - diventano silenziosissime e inalterabili nel tempo.

Officine Meccaniche Porro have patented a magnetic levitation mechanism that, thanks to neodymium magnets integrated inside flush handles, makes them extremely quiet to operate and durable over time.



QUALITÀ

Metalli nobili, tecnologie d'avanguardia e brevetti esclusivi, per una produzione di complementi per mobili, tende e scale di qualità superiore.

ASSORTIMENTO

Oltre 20.000 referenze per adattarsi a tutte le possibili esigenze sia in termini di stile che di scelta dei materiali.

LAVORAZIONI

Attente e rigorose lavorazioni controllate passo per passo, per garantire prodotti belli da vedere e con una durata nel tempo ineguagliabile.

FINITURE

Finiture con tecnologie di punta o manuali perché ogni prodotto Alfredo Porro sia all'altezza delle più elevate aspettative.

MISURE

Le misure sono espresse in millimetri. Le misure degli articoli indicate nel catalogo possono subire lievi modifiche di perfezionamento.

100% MADE IN ITALY

Tutti i complementi per mobili, tende e scale della linea Alfredo Porro - come tutta la produzione Officine Meccaniche Porro - sono garantiti come interamente concepiti e realizzati in Italia.

QUALITY

We only use noble metals, cutting-edge technology and exclusive patents to manufacture superior quality accessories for furniture, curtains and stairs.

RICH INVENTORY

More than 20.000 references to meet all of our customers' needs, both in terms of style and selection of materials.

PRODUCTION PROCESSES

Accurate and rigorous production processes and a step-by-step quality control - that is how we can guarantee products that are as beautiful as they are durable over time.

FINISHES

Finishes that rely upon cutting-edge technology, as well as manual work: each Alfredo Porro product must meet the most demanding expectations.

MEASUREMENTS

All dimensions are in millimeters. Item's dimensions indicated in the price list could vary slightly according to the finished products' requirements.

100% MADE IN ITALY

Like the entire Officine Meccaniche Porro catalog, all Alfredo Porro accessories for furniture, curtains and stairs are entirely designed and manufactured in Italy.



FINITURE A LISTINO PRICE LIST FINISHING



Oro Lucido
Polished Brass



Bronzo Antico
Antique Bronze



Bronzo Antico Etrusco
Etruscan Antique Bronze



Ottone Antico
Ancient Brass



Oro Antico
Old Gold



Nickel Lucido
Nickel Plated



Nickel Satinato
Satin Nickel



Cromo Lucido
Chrome Plated



Cromo Satinato
Satin Chrome

FINITURE A RICHIESTA FINISHING ON DEMAND



Oro Non Verniciato
Polished Brass Not Lacquered



Oro PVD
Polished Brass PVD



Bagno Oro
Gold Plated



Bagno Oro PVD
Gold PVD



Oro Antico PVD
Old Gold PVD



Oro Imperiale
Imperial Gold



Oro Satinato
Satin Brass



Patined Steel



Oil Rubbed Bronze



Matt Black/Matt White

ACCIAIO INOX STAINLESS STEEL



Acciaio Lucido

Bright
Stainless Steel



Acciaio Satinato

Satin
Stainless Steel

COLLEZIONE ZIGRINATA THE KNURLED COLLECTION



Oro Lucido

Polished Brass



Oro Satinato Opaco

Matt Satin Brass

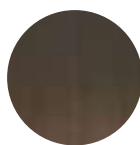

Bronzo Opaco

Matt Bronze



Nero Opaco

Matt Black



Nickel Lucido

Nickel Plated



Nickel Satinato

Satin Nickel



Cromo Lucido

Chrome Plated

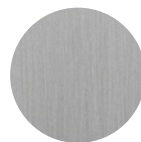

Cromo Satinato

Satin Chrome

I COLORI DELLE FINITURE SONO INDICATIVI

Alcune finiture vengono eseguite manualmente e pertanto possono presentare variazioni di tonalità e sfumatura creando doti di unicità e bellezza del prodotto.

THE COLOURS OF THE FINISHES ARE INDICATIVE

Some of the finishes are performed manually therefore variations in colour tone and shading may occur giving beauty and uniqueness to the product.

Credits

Progetto grafico / Graphic design
Adf&R S.r.l. Milano

Impaginazione / Layout
Adf&R S.r.l. Milano
OMP PORRO S.r.l.

Stampa / Printing
Arti Grafiche Meroni S.r.l.

Foto / Pictures
- I.K.B.
- Mimmo Capurso

ALFREDO PORRO



MANUFACTURED BY OFFICINE MECCANICHE PORRO

2020

omporro

officine meccaniche porro

OMP PORRO S.r.l

22060 Cucciago (CO) ITALY - via Stazione, 8/a
tel. +39 031.787100 r.a. - fax +39 031.787575

info@omporro.eu
alfredoporro.it